

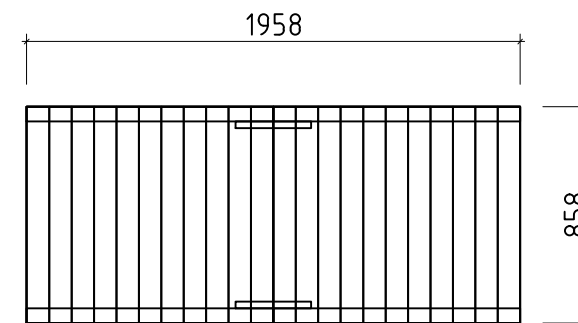

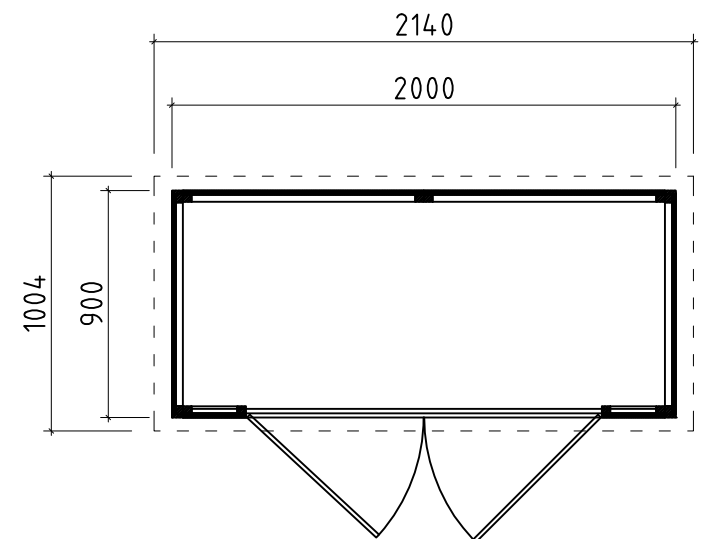

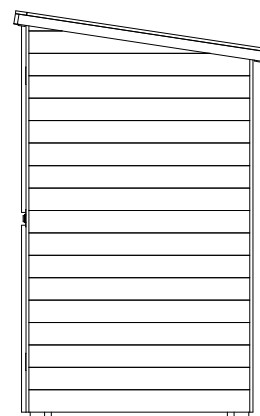

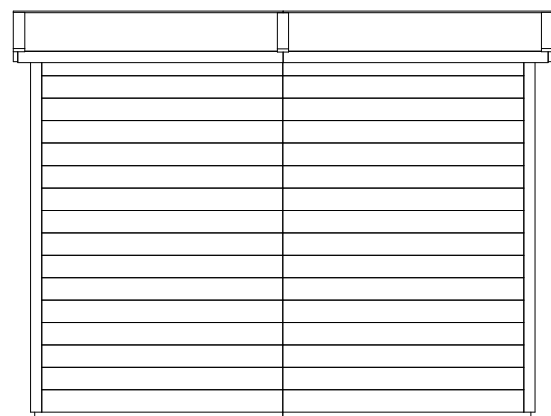
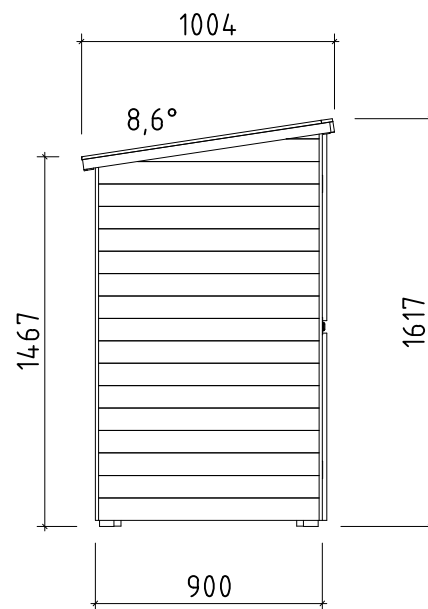
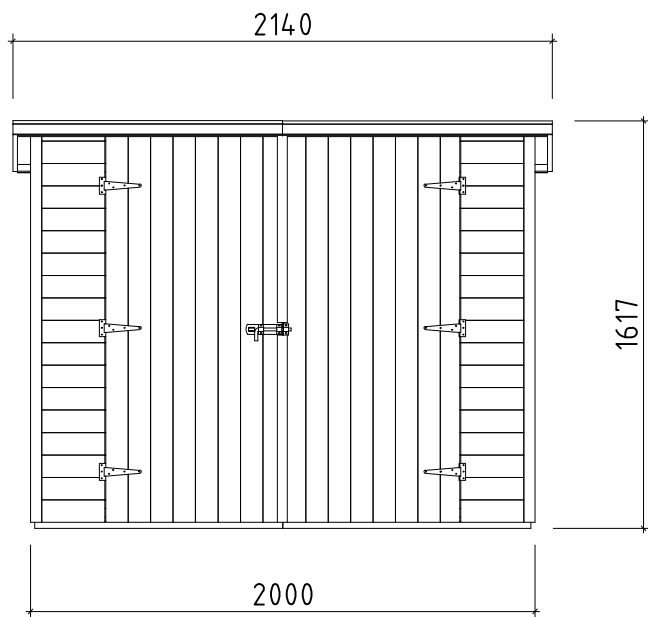
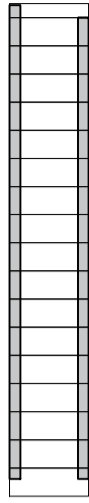
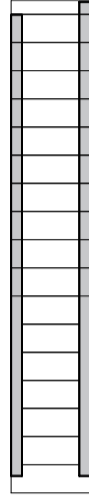
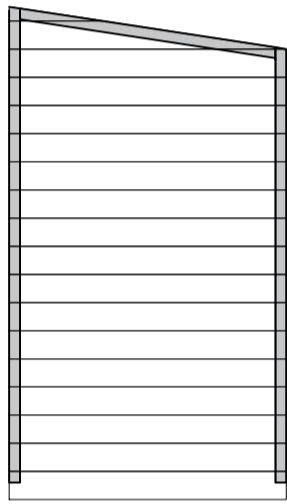
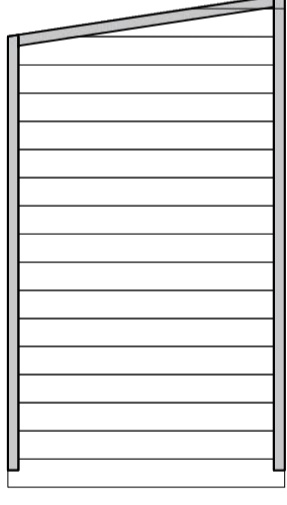
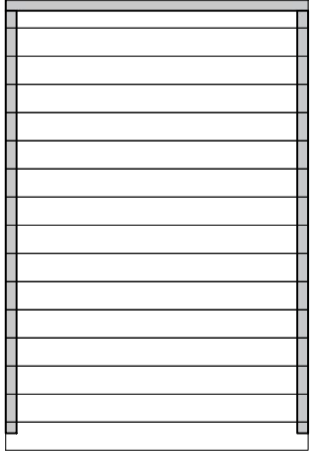
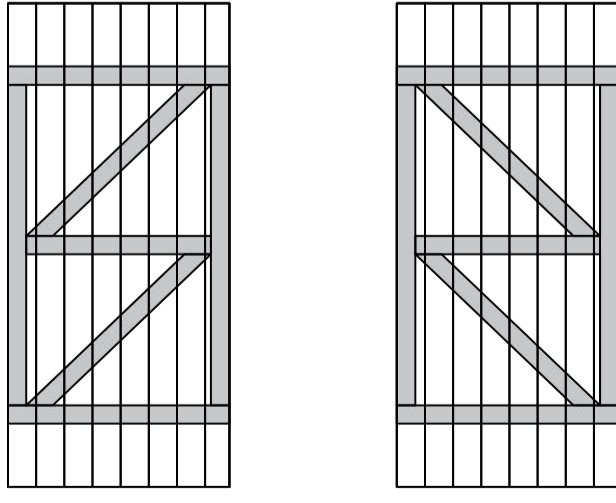
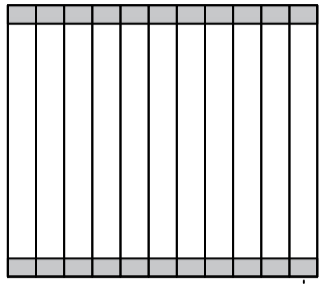
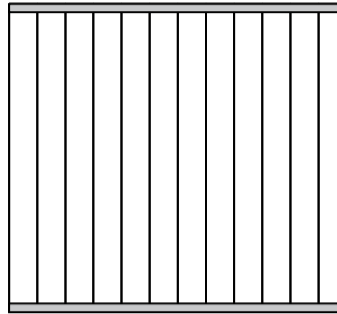
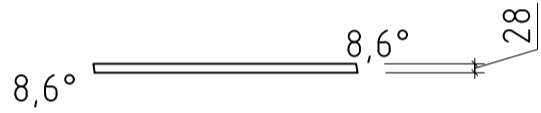
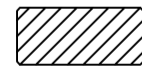
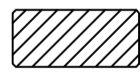
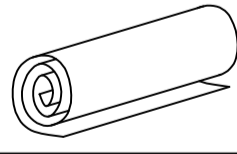
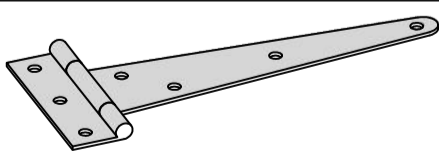
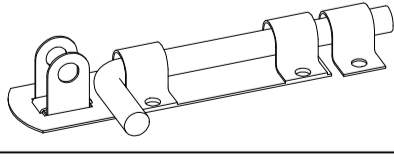
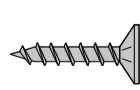
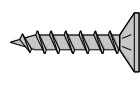

Name	Westerwald 90x200_16		
Zeichnung/ Drawing	3D	Kunde/ Client	
Profil/ Profile	1.6x8.9	Datum/ Date	29.03.2023

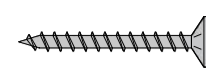
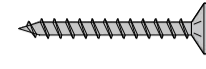
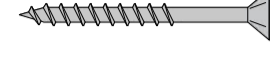

Name		Westerwald 90x200_16	
Zeichnung/ Drawing	WAND/WALL _PLAN	Kunde/ Client	
Profil/ Profile	1.6x8.9	Datum/ Date	29.03.2023

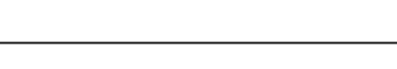
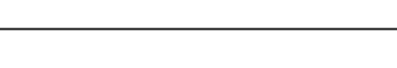
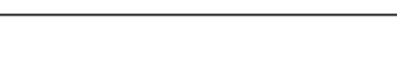
Pos	Teileliste/Specification Westerwald 90x200_16	Stck Pcs.	Profil Profile (mm)	Länge Length (mm)
EL1		1	250x1558	
EL2		1	250x1558	
EL3		1	876x1558	
EL4		1	876x1558	
EL5		2	956x1425	
	<p data-bbox="342 2249 695 2297">TÜR/DOORS DR1+DR2</p> 	1+1	700x1530	
Kood	Westerwald 90x200_16	Materjal		Leht 1/2

Pos	Teileliste/Specification Westerwald 90x200_16		Stck Pcs.	Profil Profile (mm)	Länge Length (mm)
	FUSSBODEN / FLOOR FL		2	979x858	
	DACH / ROOF RF		2	1052x975	
FH2	FUNDAMENTHOLZ (imprägniert) - FOUNDATION BEAM (impregnated)		2	27x27	300
LT12	LATTEN - STUDS		2	34x28	250
LT13	LATTEN - STUDS		2	34x28	876
LT10	LATTEN - STUDS		2	34x28	956
LT8	LATTEN - STUDS 		1	28x34	836
LE2	LEISTE - LATH		2	45x12	1557
LE5	LEISTE - LATH		2	45x12	1424
LE7	LEISTE - LATH		2	45x12	1070
LE1	LEISTE - LATH		3	45x12	960
LE8	LEISTE - LATH		1	40x18	1844
LE3	LEISTE - LATH		2	40x18	740
LE6	LEISTE - LATH		2	12x45	1052
G07-1	GIEBELLEISTEN - GABLE STRIPS 18x40		2	18x40	987
T06-1	TRAUFENLEISTEN - EAVES STRIPS 18x40		2	18x40	1070
KP-1	DACHPAPPE - ROOFING FELT			2.105m-1st	
H02	T-SCHARNIER - T-HINGE 150mm KZN		6		
R05	RIEGEL - LATCH 05- abschließbarer - lockable		1		
SR3 027	Schrauben - Screws 3.0x25 C3 LE1		15		
SR3 027	Schrauben - Screws 3.0x25 C3 LE6		6		
Kood	Westerwald 90x200_16		Materjal		Leht 2/2

Pos	Teilleiste/Specification Westerwald 90x200_16		Stck Pcs.	Profil Profile (mm)	Länge Length (mm)
SR3 032	Schrauben - Screws 3.0x30 C3	LE8 	8		
SR3 032	Schrauben - Screws 3.0x30 C3	LE3 	6		
SR3 542	Schrauben - Screws 3.5x40 C3	LE2, LE5 	12		
SR3 542	Schrauben - Screws 3.5x40 C3	Traufenleiste - eaves strips 	6		
SR3 542	Schrauben - Screws 3.5x40 C3	Giebelleisten - Gable strips 	6		
SR4 032	Schrauben - Screws 4.0x30 C3	T-Scharnier - T-hinge 	42		
SR4 062	Schrauben - Screws 4.0x60 C3	LT10, LT12, LT13 	12		
SR4 062	Schrauben - Screws 4.0x60 C3	Element + element 	15		
SR4 062	Schrauben - Screws 4.0x60 C3	Element + Fussboden - Floor 	12		
SR4 062	Schrauben - Screws 4.0x60 C3	FH2 	8		
SR4 062	Schrauben - Screws 4.0x60 C3	LT8 	4		
SR4 062	Schrauben - Screws 4.0x60 C3	Dach - Roof 	8		
SR5 032	Schrauben - Screws 5.0x30 C3	Riegel - Latch 05 	6		
	✓ - Bitte selber anpassen (falls nötig)! / Cut into length on site (if needed)!				
Kood	Westerwald 90x200_16	Materjal		Leht	2/2

Aufbau Anleitung für/Installation guide for "Westerwald 90x200_16"

1. Fußboden/Floor

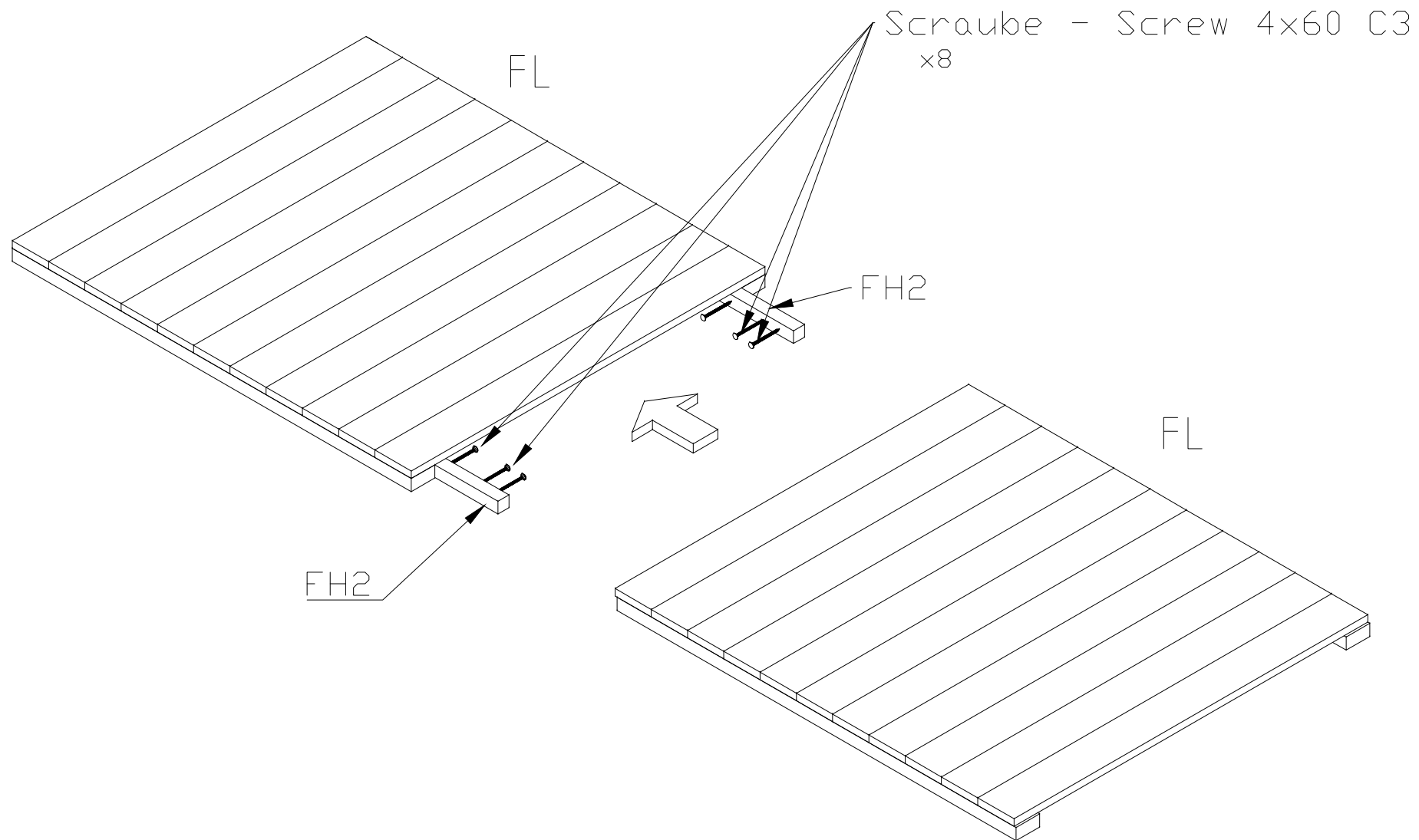

Aufbau Anleitung für/Installation guide for "Westerwald 90x200_16"

2.1 Montage der Wandelemente / Assembly of wall elements

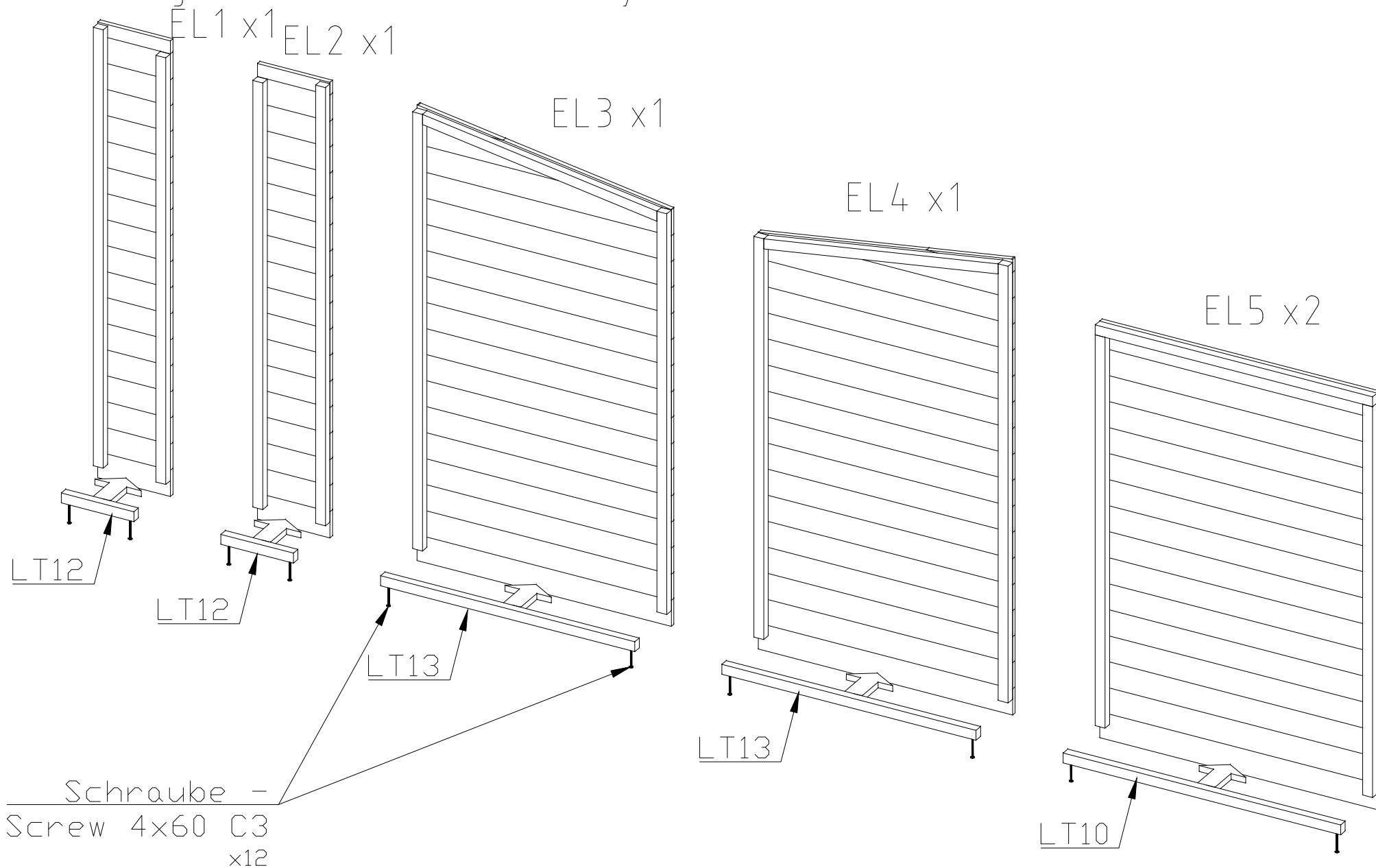

Aufbau Anleitung für/Installation guide for "Westerwald 90x200_16"

2.2 Montage der Wandelemente / Assembly of wall elements

Das Wandelement an den Fundamentholz befestigen, nicht nur an den Fussbodenbrett! / Attach the wall elements to the foundation beams not only to the floorboards!

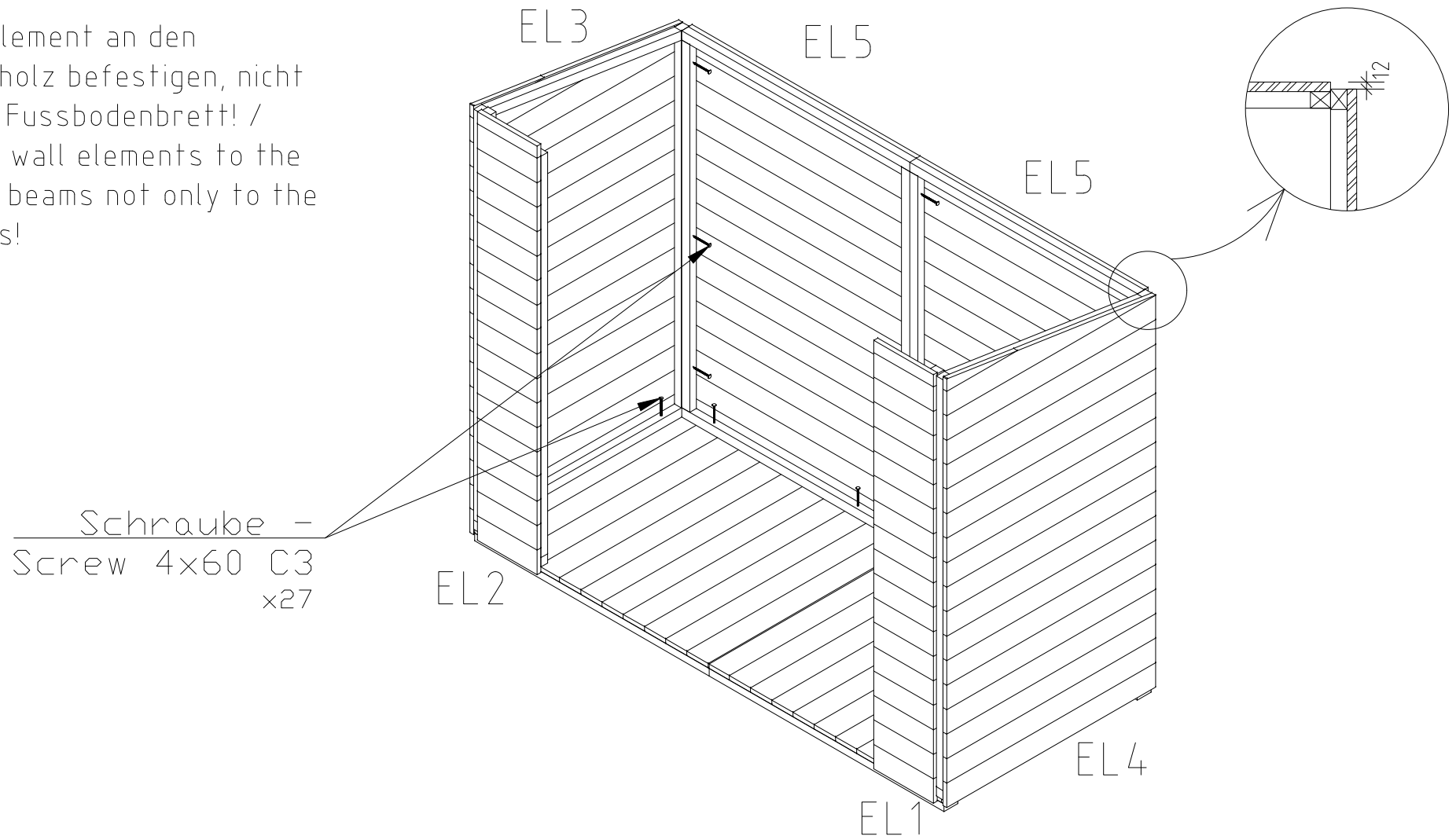

Aufbau Anleitung für/Installation guide for "Westerwald 90x200_16"

2.3 Montage der Wandelemente / Assembly of wall elements

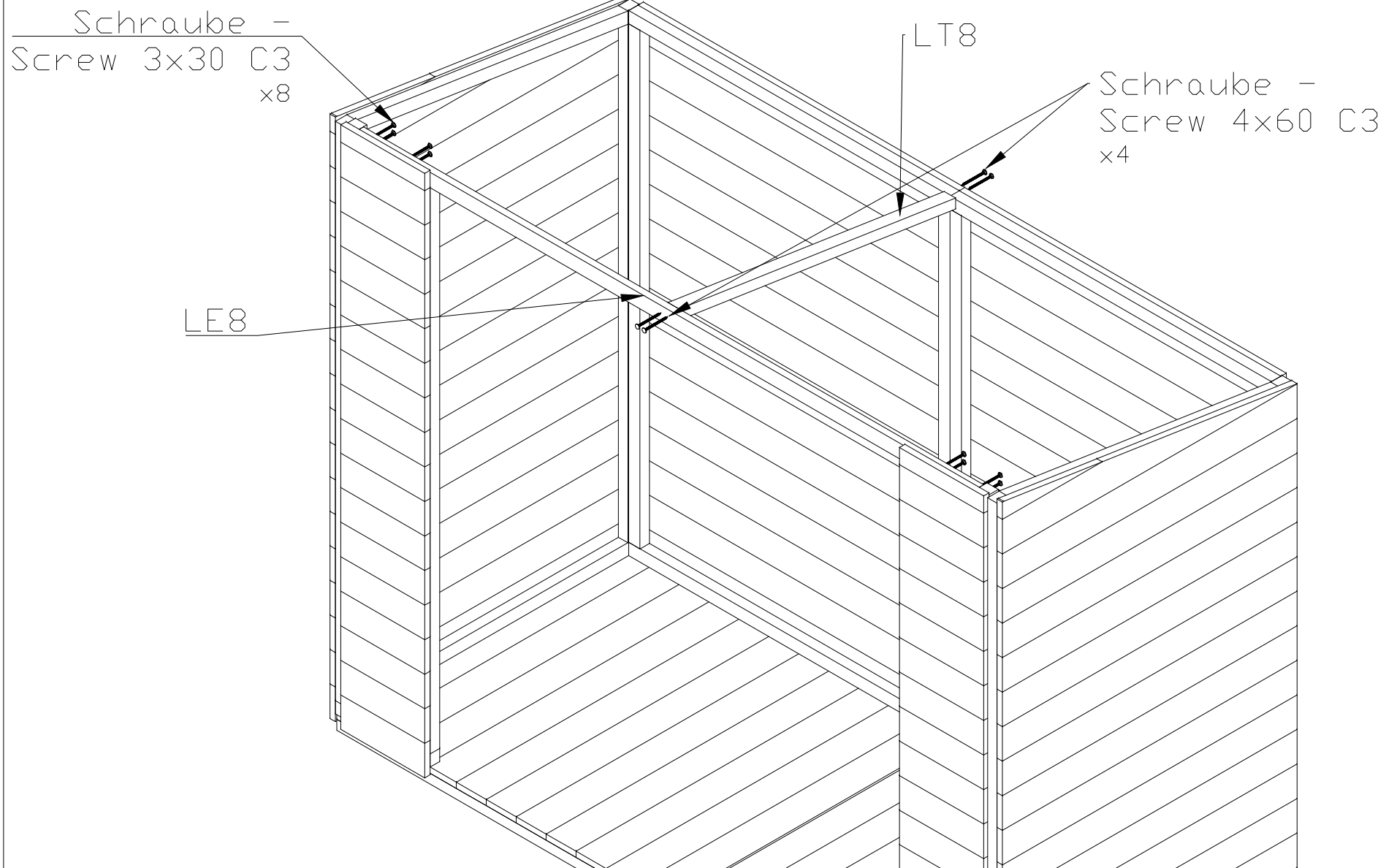

Aufbau Anleitung für/Installation guide for "Westerwald 90x200_16"

3. Tür / Door

Riegel-Latch 05

Schrauben -
Screw 5x30 C3
x6

Schrauben
Screw 4x30 C3
x42

T-Scharnier
T-Hinge

DR-Tür - Door

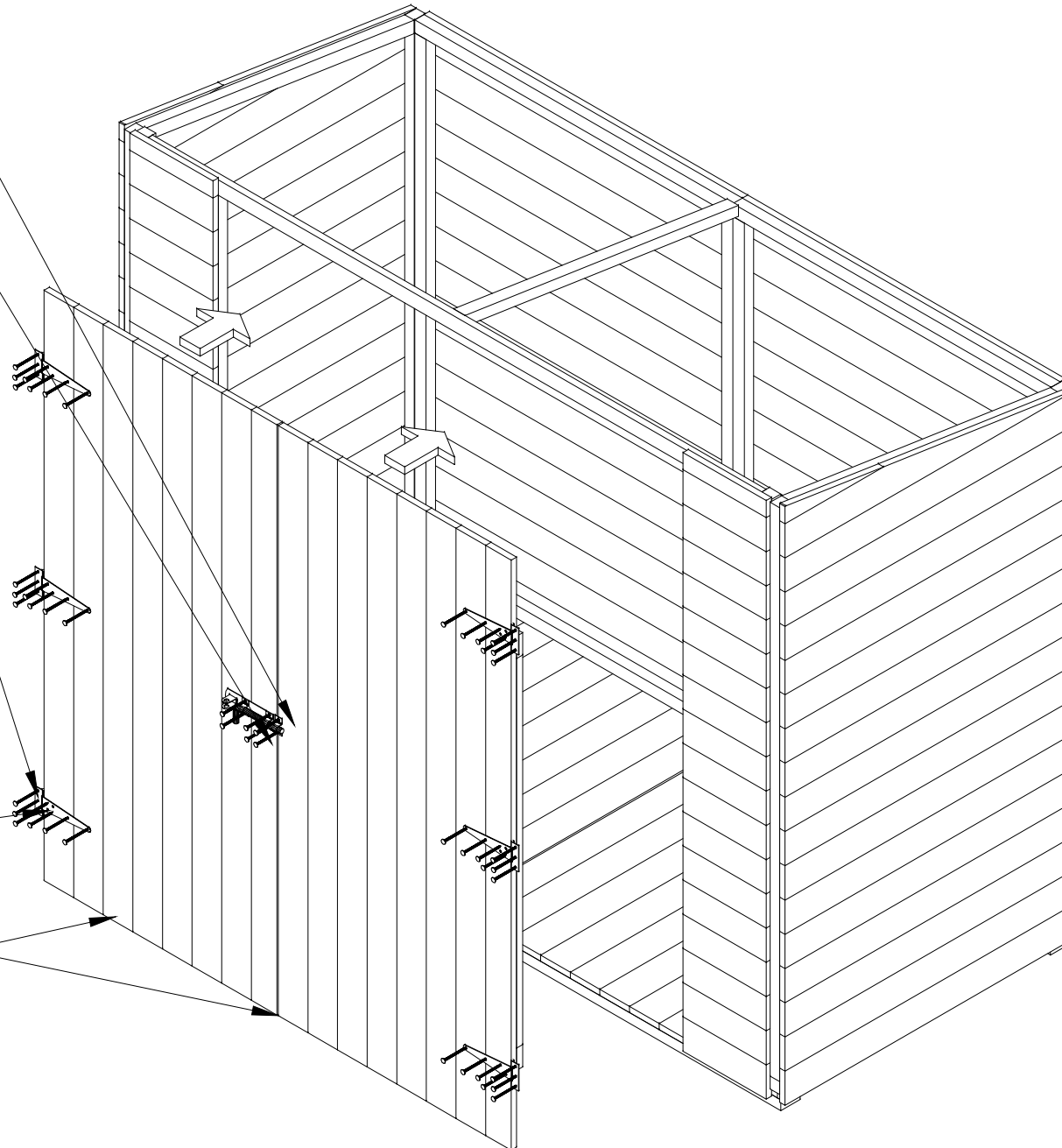

Aufbau Anleitung für/Installation guide for "Westerwald 90x200_16"

4. Leiste - Lath

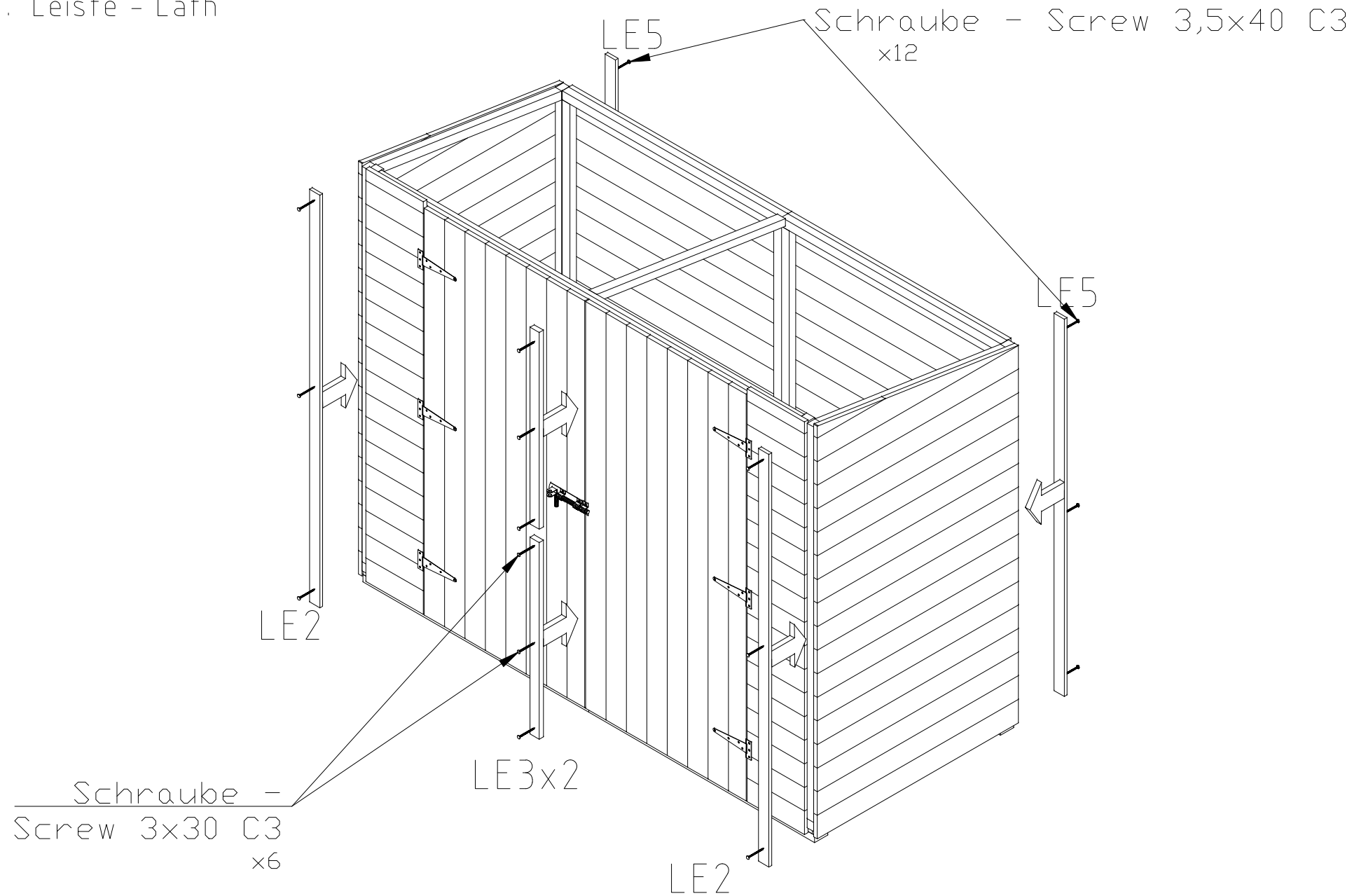

Aufbau Anleitung für/Installation guide for "Westerwald 90x200_16"

5. Dach / Roof

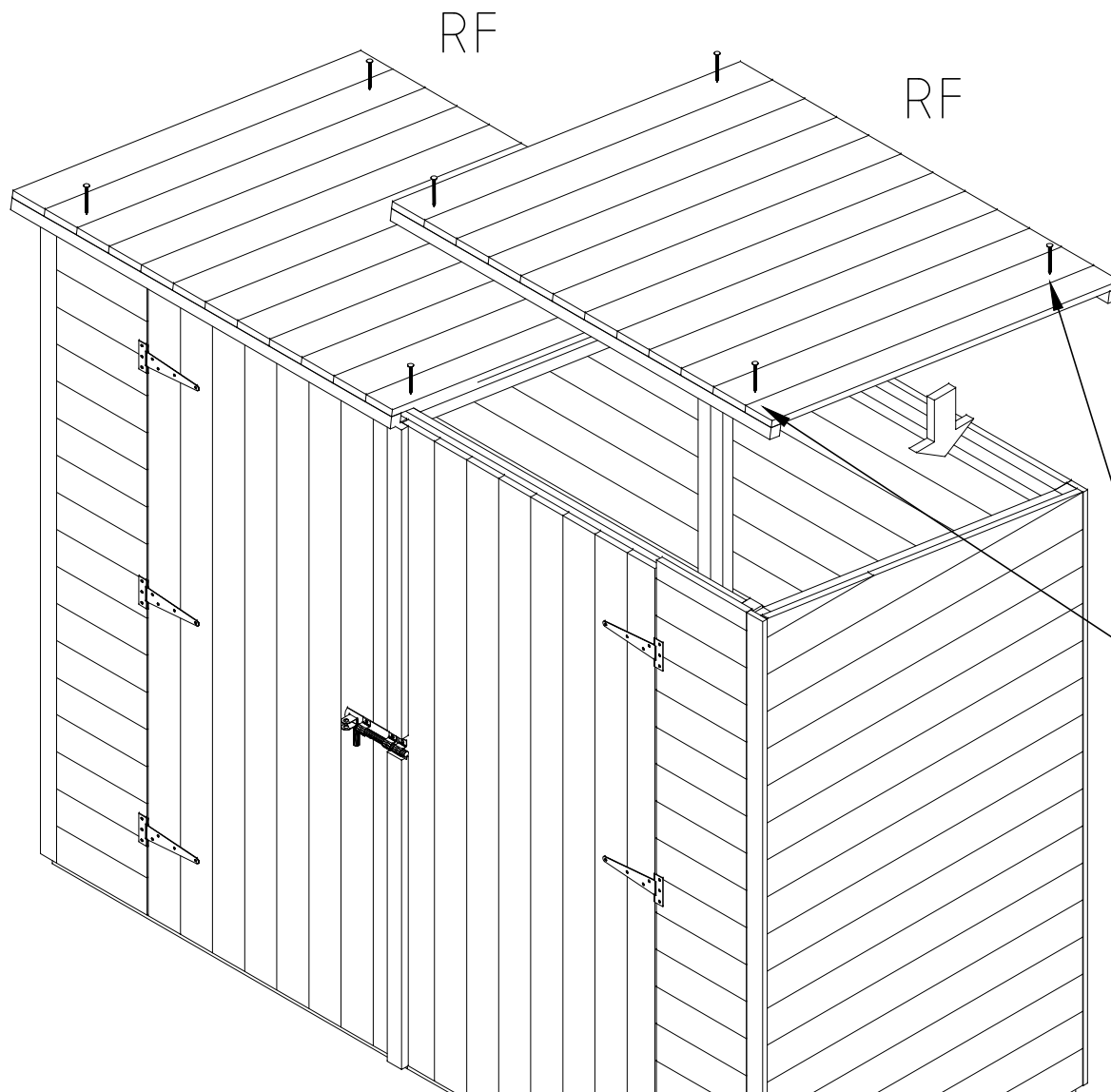

- × Befestigen Sie das Dach von der Ecke
- × Fix the roof from the corner

Schrauben
Screw 4x60 C3
x8

Aufbau Anleitung für/Installation guide for "Westerwald 90x200_16"

6. Dachleisten - Foof strips

